

Users Operating & Maintenance Instructions

Whirlpool Bath System plus LED* (Optional see 10/11)

British and European safety standards.

1. This appliance is not intended for use by persons (including children) with reduced physical, sensory or mental capabilities, or lack of experience and knowledge, unless they have been given supervision or instruction concerning use of the appliance by a person responsible for their safety. (Young children must be supervised at all times)
2. Children should be supervised to ensure they do not play with the appliance.
3. The system should be isolated from the electrical power supply when not in use.
4. Always run cold water into the bath when filling before turning on the hot tap.
5. Before activating your whirlpool system, please ensure that the side suction filter is clear, all the whirlpool jets are submerged and the water level is beneath the overflow of the bath. The whirlpool system **should not** be activated if the water level is at or above the overflow level. (If the water level is at the overflow level or above then the air control for the whirlpool must be switched to the off position. Diagram 2 below refer to point 8)

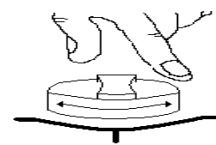
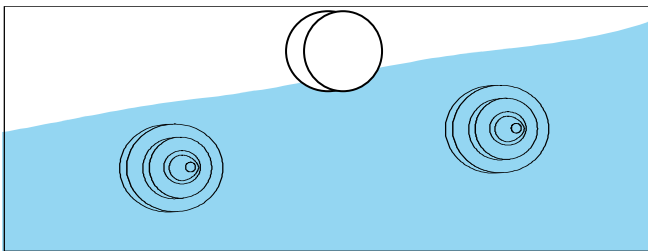

Air regulator- turn clockwise and anti clockwise to adjust the air intake.

- 1.
- 2.
6. Use bath additives sparingly. Add only a drop of bath additive at a time while the whirlpool is running. When using any **products specifically made for Whirlpools** please follow the instructions on the label.
7. Activate your whirlpool bath by pressing the control button located on the side of the bath once. Similarly, to turn the system off, press the button once again. (Diagram 1)

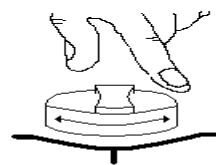
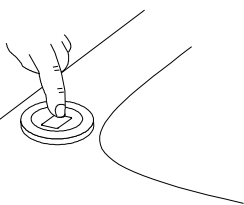

Air regulator- turn clockwise and anti clockwise to adjust the air intake.

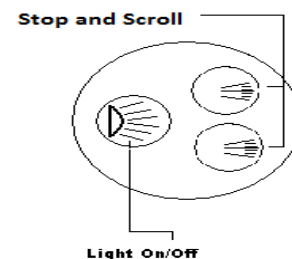

- 1.
- 2.
- 3.
8. It is possible to adjust the force of the jets by rotating the outer circular air controller clockwise or anti-clockwise whilst the whirlpool system is in use. (Diagram 2)
9. We recommend that you do not use the whirlpool for too long at first. Start by using the system for 7 – 10 minutes at a time. Gradually build up to 20 or 30 minutes once your body is used to the massage effect.
10. To activate your multi colour changing L.E.D. light press the electronic Light button once, to turn the light off simply press again. (Optional)* (Diagram 3)
11. To scroll and stop use the alternative buttons on the electronic switch to activate these accordingly. (Diagram 3)

General Maintenance

1. To ensure the lasting quality of your whirlpool system, we recommend that once bathing is complete and the bath is emptied, you wipe the jet covers, suction cover and the bath with a soft damp cloth to remove any soap residue or grime.

2. **Standard System.** After use, ensure the suction filter remains clear and is not blocked by soap, hair or any other debris. If the inlet filter is not clear, remove the cover by undoing the retaining screw and clean the filter.

Standard System

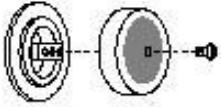

WARNING:

After removing and cleaning the suction filters it is essential for personal safety that they are ALWAYS REPLACED immediately.

General Hygiene

In accordance with normal hygiene practice, it is essential to clean the inner pipe work of your whirlpool system using a **Whirlpool Cleaner** and a sterilising fluid.

For all cleaning purposes please follow the step by step instructions on the label of the **Whirlpool Cleaner** bottle purchased.

Important notes

- When the system is not in use, we recommend that the electrical power supply is turned off at the isolation switch.
- The RCB (circuit breaker) must be checked typically on a monthly basis by pressing the test button.
- If the bath is not to be used for any length of time such as holiday periods, it is recommended that the system should be sanitized using a **Whirlpool Cleaner** after the last bath before you leave and again before using the bath upon your return.
- The system has been designed to achieve optimum drainage. Drops of water will continue to drain out of the jets and suction for some time after the bath is emptied, this is quite normal.
- Normal domestic bathroom cleaners can be used on all the whirlpool system fittings. Abrasive cleaners **MUST NOT** be used on chrome fittings.
- The pneumatic switch is water resistant but not entirely waterproof, therefore when installing the system the position of the shower or other water source should not be directly applied upon or over the top of the switch.
- Under normal operating conditions, no servicing of the system should be required for the life of the product. There are no user serviceable components. If a fault does occur please **contact your supplier**. Attempts to modify any of the components may cause damage and invalidate any warranty.
- For further information on obtaining a Whirlpool Cleaner and maintaining your Whirlpool system please contact our Customer service helpline on 01484 546955.

Installation Instructions

Whirlpool Bath System (optional LED*)

Please read the following instructions carefully before and during installation.

Tools Required (Not Supplied)

Electric Drill Adjustable Spanner Cross Head Screwdriver Spirit Level Terminal Screwdriver
--

Before You Start

- Remove all transit packaging and clear protective film from acrylic.
- ***Check for any sign of damage to the bath & associated pipework prior to installation.***
- Do not lift or manoeuvre the bath by the plastic pipes.
- It is recommended that the bath be covered by a sheet or blanket during installation.
- **Once installation has commenced claims for damage cannot be considered.**

Installation

Important.*LED lights are factory fitted for optimum effect, please handle with care and avoid twisting, moving or adjusting.

Important: Permanent bath panelling is not advised as the pump and system must be accessible.

Plumbing Procedure

1. **Do not** position bath with switch directly beneath the shower head.
2. Manoeuvre the bath into its final position.
3. Set the bath level to its correct height by adjustment of the threaded bath feet, when doing so to accommodate the panel or other, the screwed rod must be adjusted down inside the hollow foot.
4. Check that the bath panel to be used fits correctly & clears the pump & pipework.
5. Lock off the bath feet by tightening the lock nut on each adjustable bath foot.
6. Check that the bath is level & panel fits.
7. The water & waste connections can now be made.
8. Please refer to and complete **Testing and Initial Operation Procedure** points **3, 4, 5** and **6**.
9. Fix the bath to the wall with the screws and L shaped wall brackets supplied.

Electrical

WE STRONGLY RECOMMEND THAT ALL ELECTRICAL INSTALLATION WORK IS CARRIED OUT AND TESTED BY A SUITABLY QUALIFIED ELECTRICAL ENGINEER.

1. All electrical wiring should conform to the requirements of the Regulations for Electrical Installations, published by the Institute of Electrical Engineers.
2. Supply requirements 230 V AC single phase 13A.
3. The appliance should be supplied through a residual current device (RCD) having a rated residual operating current not exceeding 30mA. The supply line should be fed via a suitably rated double pole isolator having a minimum gap separation of 3mm in all poles. The isolator and RCD must be fitted outside the bathroom area (this may be sited in the consumer unit or separately). This appliance must be permanently connected to fixed wiring.
4. All electrically conductive parts of the installation – Hot & Cold pipes, metal support frame, metal baths etc, must be bonded together at the mains supply EARTH terminal with a conductor of not less than 6mm² in cross sectional area.
5. The pump is factory fitted with a 4metre length of twin and earth flex for connecting to the power supply (if the supply cord is damaged. It must be replaced by the manufacturer, its service agent or similarly qualified persons to avoid a hazard). The cable is connected to the motor using a suitably rated IP cable gland. Electrical connection to this flex should be made outside the bathroom area, should connection be made within the bathroom area the connecting device must be rated at least at IP55.
6. There is no need to remove the terminal block cover of the motor.
7. Parts containing LIVE PARTS, except parts supplied with safety extra low voltage not exceeding 12V must be inaccessible to a person in the bath.
8. Parts incorporating electrical components, except remote control devices, must be located or fixed so that they cannot fall into the bath.
9. Please ensure that at all times when operating and using the system that no other appliances are used in or are in the close proximity of the bath.

Means for disconnection must be incorporated in the fixed wiring in accordance with the wiring rules

Wiring Diagram

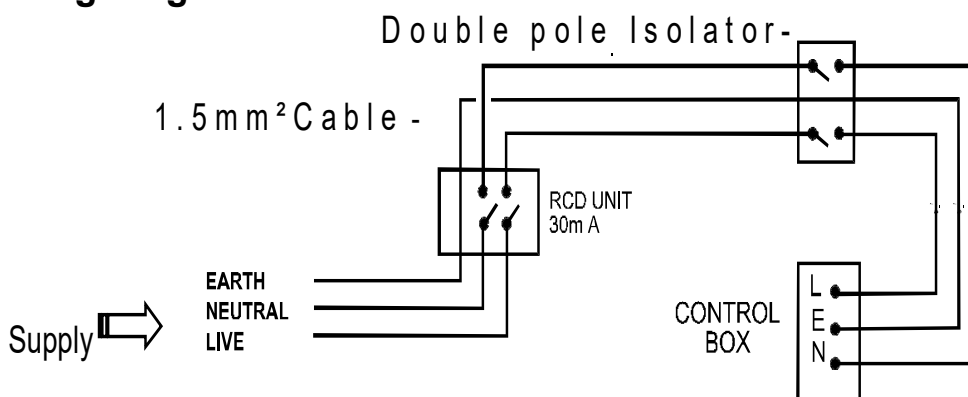

Testing and Initial Operation

This should be carried out before bath panels are fitted and tiling is completed.

1. Isolate the power supply.
2. Ensure that the bath is clear from debris, ensure suction fitting and jets are free from any dirt or debris.
3. Ensure the clear pneumatic tube (5mm) is **firmly connected** to both the pump and underside of the switch, free from any obstructions. (not applicable to the electronic switch)
4. Check pump and waste connections are tight.
5. Fill the bath with water to 25mm above the whirlpool jets but beneath the overflow.
6. Check pipework, pump and waste connections for any sign of water leaks.
7. Switch on the electrical supply to the unit and press the on/off button once to operate the system. (Refer to point 3 if this does not happen)
8. Check pipework and pump for any signs of leaks. Run system for a minimum of 10 minutes whilst continuously checking for leaks.
9. While the system is operating open the air control (turn anti-clockwise) Check the jets are working, Closing the air control (turn clockwise) should eliminate virtually all the air bubbles from the jets.
10. If the system is leak free and operates correctly, drain the bath and complete the installation.

Installation Trouble Shooting Guide

Problem

Check

System will not operate.

Check the electrical isolator & RCD are turned on and fuses / circuit breakers are active.

Check the pneumatic air hose (5mm) is connected between the pump & the underside of the push button on the rim of the bath. (If electronic refer to point 3 above)

Check that the suction filter on bath wall is not blocked. (Standard system).

Check that the suction waste filter cup is not blocked.

Ensure that water covers the jets by at least 25mm but the level is beneath the overflow.

Turn off the electricity supply and check the electrical connections.

Water draining away.

Please adjust brass nut and screw on plug or remove completely if needed.

Check below bath to ensure lower D&O mechanism is not impeded by pipe work or other.

The system has been fully inspected and rigorously tested at our factory. If upon installation it does not operate correctly or leaks occur, **contact your direct supplier immediately**. Attempts to repair or modify any part of this product may cause damage and invalidate the warranty.

Revised Building Regulations

As of January 2005, changes to the Building Regulations affect domestic electrical installations in England and Wales. You do not need to be a qualified electrician to make changes to your home's electrical system, but the work must be done in accordance with the standards set out in the Building Regulations.

You do not need to notify your Local Authority if you do **minor** electrical work such as:

- Replacing or repairing a **socket, light** or **cable** in any room.
- Adding extra **spurs, sockets** or **lights** to an existing circuit (*except in a kitchen, bathroom, or outdoors.*)

However, the work must be done to the standards in the Wiring Regulations and you should consider having the work checked by a competent electrician to make sure it is safe for use.

Before you start other electrical work such as:

- Adding **new circuits** to your existing installation.
- Any work (*other than repairs / replacements*) in a room with **water**. (*E.g. Kitchen, Bathroom etc.*)
- Any work (*other than repairs / replacements*) **outdoors**. (*E.g. installing garden lighting or sockets, etc.*)

You must **notify** your Local Authority Building Control Department, which has responsibility for ensuring all work is **inspected and tested**.

Where you have any work done by an electrician who is a member of a *Competent Person Self-Certification Scheme*, the electrician will be able to certify the work complies with the Building Regulations and you do not need to notify your Local Authority.

We recommend that you make yourself aware of the revised Building Regulations before you undertake any work and if you require any clarification, you should contact your Local Authority Building Control Department.

Two Year Warranty

Whirlpool bath system (optional LED*)

Warning: We highly recommend the use of a Whirlpool Cleaner to maintain the whirlpool system, failure to do so may cause harm to your system and could invalidate your two year warranty.

Warranty number

To register for your free warranty you simply complete and detach the Warranty Form below and return to the Aquair address below.

Conditions

1. This warranty is valid for 2 years from the date of purchase.
2. Aquair's only obligation under the warranty shall be to repair or replace the faulty system at Aquair's discretion. This will be carried out where the fault arises from defects within the system resulting from either material or workmanship of the manufacturer.
3. This warranty does not cover malfunction or damage arising from incorrect installation, misuse of the system or use of bleach/abrasives on chrome or gold finishes, in which case a charge may be levied.
4. Aquair cannot accept responsibility for any costs arising from repair carried out by any third party.
5. The warranty on parts which are exchanged ends when the warranty on the system expires.
6. This warranty does not affect your statutory rights.

Your whirlpool system comprises of:

- a. Pump. b. Switch. c. Pipe work. d. Couplings and jets e. LED*

Customer Service Department

Should you have any queries or problems contact Aquair's Customer Service Department, open Monday to Thursday 9am to 5pm.

Telephone 01484 546955

Email: technical@trojanplastics.co.uk

Please complete details below and return within 28 days to register your purchase.

Warranty number

Name

Address

.....

.....Post Code

Telephone Number

Please tick box should you not wish to receive further information from Aquair

Signature Date

**Please return to Trojan Plastics Ltd, Ashbrow Mills, Ashbrow Rd, Huddersfield.
West Yorkshire. HD2 1DU.**