

INSTALLATION

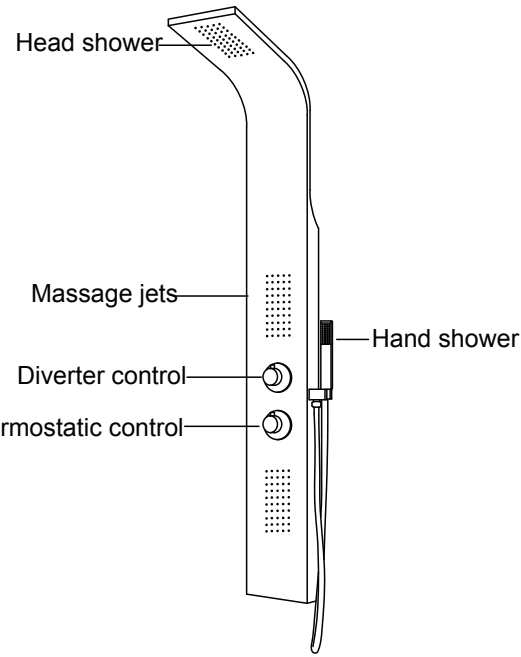





Shower Panel

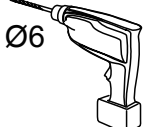

If you want to increase hot water, please push the button and turn.

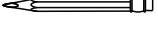
Parts List

FOR INSTALLATION YOU WILL REQUIRE

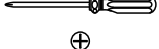
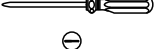
| | | | | |
|--|---|---|---|---|
|  |  |  |  |  |
| Electric Drill | Tape measure | Wrenches | Pencil | Hexagonal wrench |
|  |  |  |  | |
| Hammer | Sealing Tape | Screwdriver | Screwdriver | |

Note: Always check the walls for pipes and wires before drilling.

Steps:

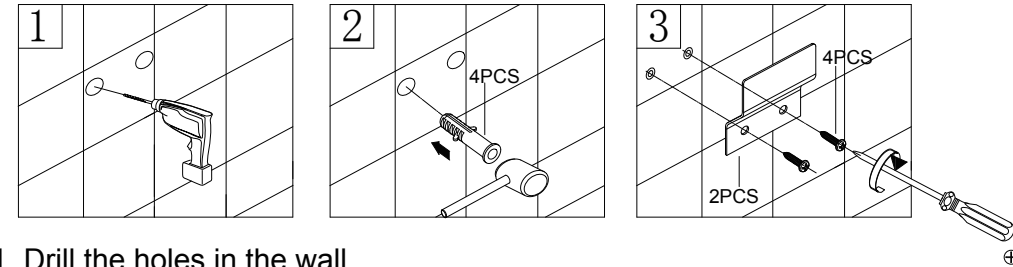

1. Drill the holes in the wall.
2. Insert the wall plugs inside the holes.
3. Tighten the screws to the wall with wall mounting brackets.

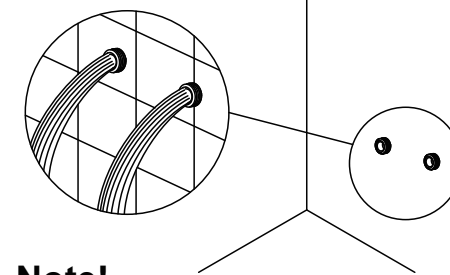
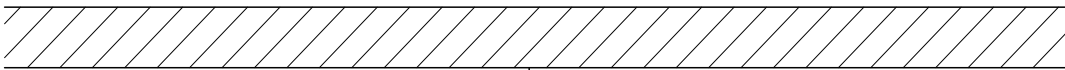

Note!

Before assembly, flush the water supply pipes thoroughly to remove debris (allow the water to run with the main stopcock open for about 3 mins), otherwise dirt particles might affect the function of the shower panel!

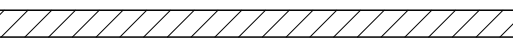

Shower holder installation guide

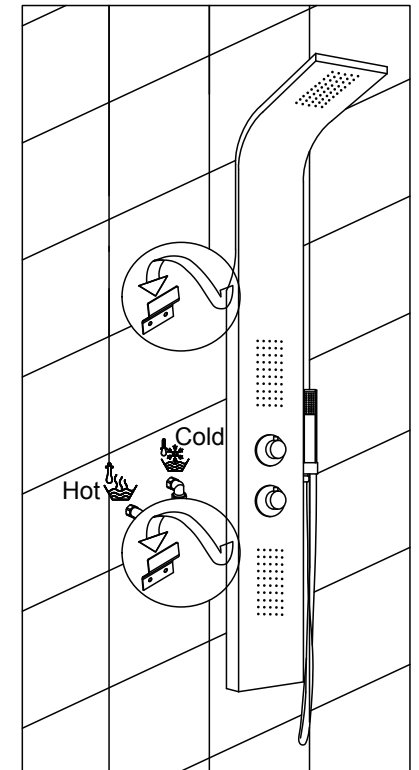
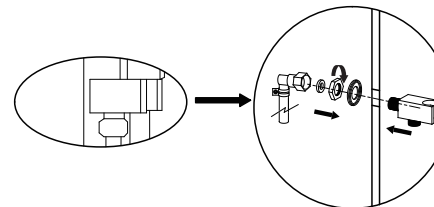

Note: No harsh abrasive cleaning agents or materials can be used. Use a clean damp cloth only.



NOTE: PLEASE CARRY OUT THE FOLLOWING STEPS,IF CLEANING /MAINTENANCE IS REQUIRED

Removal process

① Take off cap

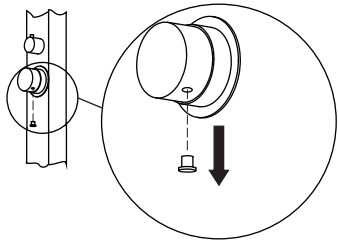

② Loosen HEX screw off with hexagonal wrench

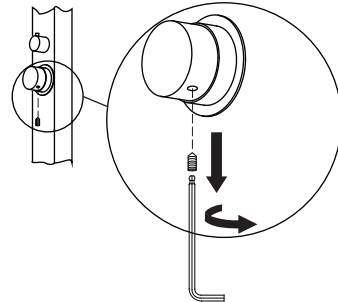

③ Take off head

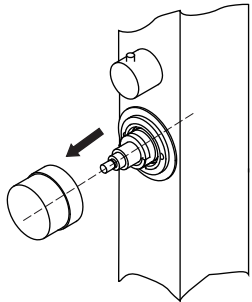

④ Take off ring

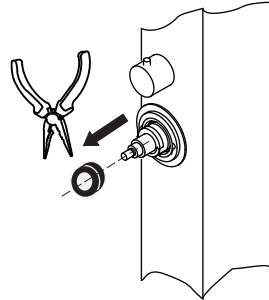

⑤ Unscrew the brass ring from the valve using the tool

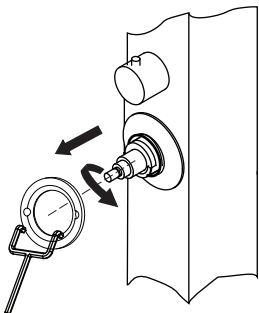

⑥ Remove the valve and clean: Run under warm water and use a toothbrush or similar to remove any debris or limescale

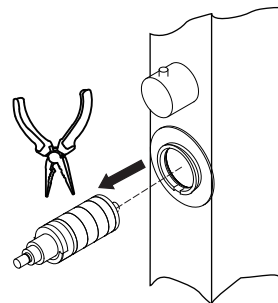

Installation process

① Put the valve back

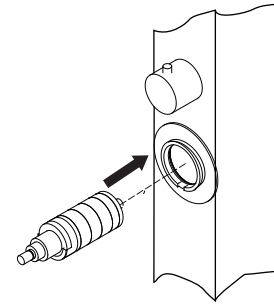

② Put brass ring on top of valve

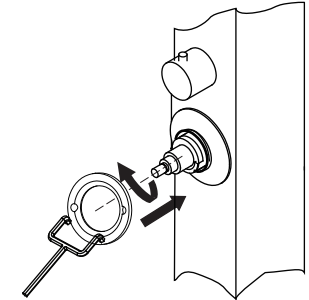

③ Put ring in place

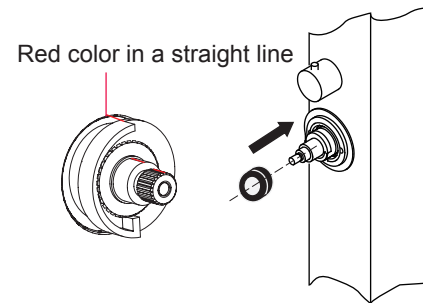

④ Press the button on the valve and put on the head as below ensuring the screw hole pointing to the front

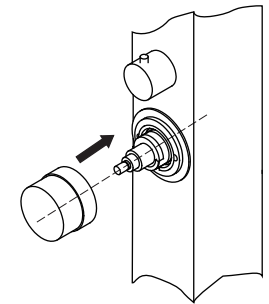

⑤ Use hexagonal wrench to fix the HEX screw tightly

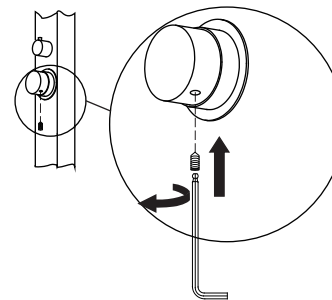

⑥ Put on cap

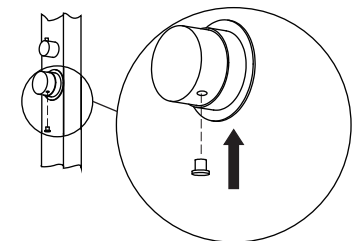

Check out our full range of Showers

Electric Showers

Digital Showers

Mixer Showers

Power Showers

Smart Showers

Shower Towers

From Top Shower Brands

Mira Showers

Aqualisa Showers

Triton Showers

Gainsborough Showers

Shower Pumps can upgrade your showering experience even more

Stuart Turner Shower Pumps

Salamander Shower Pumps

Grundfos Shower Pumps

plumbworld
Big brands, small prices.